



products with a watertight reputation

## BLUECUBE+ AQ-BC-5UBT 'HIDE-AWAY' MEDIA PLAYER

for Bluetooth, USB, iPhone, iPod, MP3 devices and FM Radio

### USER / INSTALLATION MANUAL



! PLEASE READ THIS INSTRUCTION MANUAL BEFORE INSTALLATION AND OPERATION !

<b>1 Getting Started</b> .....	<b>3</b>
1.1 Contents.....	3
1.2 Connections.....	3
1.3 12-pin Harness Connection.....	4
1.4 Mounting the BlueCube+ Media Player.....	4
1.5 Power On.....	5
1.6 Remote Control Battery Install.....	5
1.7 Remote Control Synchronizing.....	5
<b>2 Location of Controls</b> .....	<b>6</b>
2.1 Wireless Handheld Remote Control.....	6
2.2 Wired Remote Control.....	6
<b>3 Listening to Devices</b> .....	<b>7</b>
3.1 Listening via USB.....	7
3.1.1 iPhone & iPod Search.....	7
3.1.2 Device Charging.....	7
3.1.3 iPhone & iPod Compatible Models.....	8
3.2 Listening via Bluetooth.....	8
3.2.1 Pair with Bluetooth Device.....	8
3.2.2 Listening via Bluetooth Device.....	8
3.3 Listening via Auxiliary Input.....	8
3.4 Adjust Volume Level.....	8
<b>4 Listening to FM Radio</b> .....	<b>9</b>
4.1 Enter FM Radio Mode.....	9
4.2 Scan or Seek FM Radio Channels.....	9
4.3 Saving Radio Channel to Memory.....	9
4.4 Listening to Saved Radio Memory.....	9
4.5 Switch between US and European FM Modes.....	9
4.6 Adjust Volume Level.....	9
<b>5 Additional Features</b> .....	<b>10</b>
5.1 External 12V Trigger.....	10
<b>6 Specifications &amp; Dimensions</b> .....	<b>11</b>
6.1 Specifications.....	11
6.2 Dimensions.....	11
<b>7 Warranty Information</b> .....	<b>12</b>

## 1.1 Contents

- AQ-BC-5UBT BlueCube+ Media Player
- 2-Way RF Waterproof Remote Control (AQ-RFBC-5UBT)
- Wiring Harness (AQ-UNH-2)
- Four (4) Stainless Steel Mounting Screws
- One (1) CR2450 Battery
- Owner's Manual

## 1.2 Connections

### 1. 12-pin Watertight Harness

The 12-pin harness supplies power and ground connections to the BlueCube+ Media Player and four (4) speaker channel output connections from the BlueCube+ Media Player.

 Do not cut or modify the 12-pin harness on the unit side or warranty will be void.

### 2. FM Radio Antenna Jack

Connect antenna (AQ-ANT-1 sold separately) to female antenna receptacle. For best FM performance make sure the antenna is extended to the highest achievable position.

### 3. Auxiliary Outputs - Rear

Allows external amplifiers to be connected to power additional speakers.

### 4. Auxiliary Outputs - Front

Allows external amplifiers to be connected to power additional speakers.

### 5. Auxiliary Inputs

Connect to a portable audio player through the AUX IN cable on the back of the Digital Media Box.

### 6. 12V DC External Trigger

Allows for an external light or relay to be triggered (350mA max load).

### 7. USB Connector

Connect a USB device play music.

### 8. Wired Remote 8-pin DIN Cable

Connect to wired Remote Control.

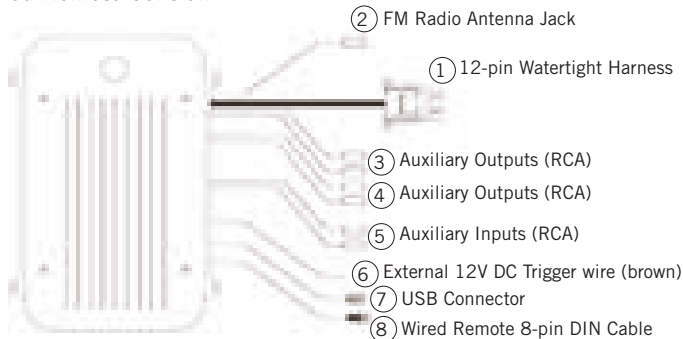

## 1.3 12-pin Harness Connection

The AQ-BC-5UBT includes the universal harness AQ-UNH-2 in order to connect the BlueCube+ to power and speakers.

All open wire connections should be soldered and protected against water and dust for best long term performance.

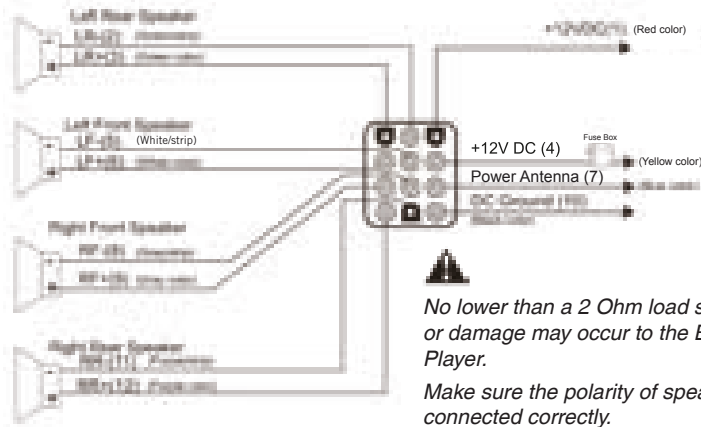

## 1.4 Mounting the BlueCube+ Media Player

1. Make sure the outside surface is clean and clear of debris.
2. The BlueCube+ Media Player has four (4) mounting screws. Drive the screws using a screw driver. Make sure screws are snug and do not over tighten.

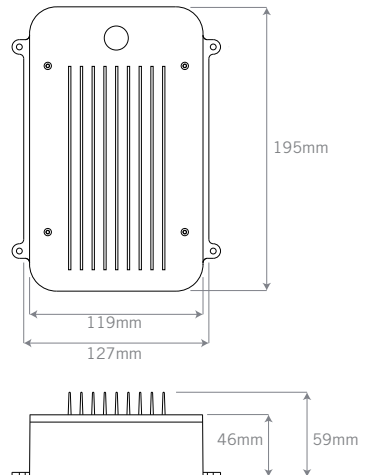

## 1.5 Power On

The AQ-BC-5UBT requires +12V DC to both the red and yellow wires. When both of these wires have power the AQ-BC-5UBT is powered on and is indicated by a red LED on the harness grommet of the stereo.

In a spa application this requires the red and yellow wires to be jumped together and then connected to the +12VDC output of the power source. In this set up the AQ-BC-5UBT will always be on, with a very low current draw when idle.

In a boat, ATV or other application requiring power from a battery, the yellow wire (constant power) should be connected to the battery, and the red wire connected to the ignition or a switch.

For detailed instructions you can check out our online video:

‘How to wire your Aquatic AV stereo system’  
<http://www.aquaticav.com/support/videos>



## 1.6 Remote Control Battery Install

Remove the RF wireless remote control from the BlueCube+ Media Player box. Unscrew the waterproof cap on the back of the remote control. Place the CR2450 battery in the RF remote control and replace the water/dust proof cap.

When the battery is installed, the remote control LCD should be solid and bright without any flickering.

## 1.7 Remote Control Synchronizing

The remote should already be paired from the factory, but if you need to re synchronize the remote follow the steps below.

1. Press the  POWER button on the remote control to turn on the remote.
2. The LCD will become illuminated and read ‘NO LINK’.
3. Press and hold the  MODE button for 5 – 10 seconds.
4. Once the remote has been paired, the LCD will display one of the audio modes (FM, USB, BT AUDIO).

For any additional remote controls, you will also need to activate/synchronize those remote controls by following the steps above.

**i** *If the pairing process is not effective, check the battery voltage of the remote. If above 3V DC refer to section 1.5 above to make sure the battery is installed correctly. If battery voltage is below 3V DC replace the battery.*

**i** *If the LCD displays “NO LINK” in any mode, this means the remote is out of reception range or not paired correctly. Move the remote closer to the unit and try again.*

**i** *If you lose your remote control and buy a new remote control, please follow the above to pair remote control.*

## 2.1 Wireless Handheld Remote Control AQ-RFBC-5UBT

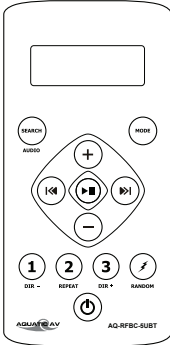

Buttons	Music Mode: iPhone, iPod, Bluetooth, USB & MP3	FM Radio Mode
Power	Press once: Toggle from Operation mode to Standby mode or vice-versa.	
Mode	Press once: Change the source. Press and hold: Pair	Press once: Change the source. Press and hold: Pair
Search/Audio	Press once: NAVI search function Press and hold: Press and hold: Audio Menu (BAS-TRE-BAL-FAD-EUR-DX-MONO-STEREO)	Press once: Audio Menu (BAS-TRE-BAL-FAD-EUR-DX-MONO-STEREO)
Volume Up	Press once: Volume up Press and hold: Fast volume up	Press once: Volume up Press and hold: Fast volume up
Volume Down	Press once: Volume down Press and hold: Fast volume down	Press once: Volume down Press and hold: Fast volume down
Fast Rewind	Press once: Previous track Press and hold: Fast rewind	Press once: Scan down Press and hold: Toggle manual seeking
Fast Forward	Press once: Next track Press and hold: Fast forward	Press once: Scan up Press and hold: Toggle to manual seeking
12V Trigger / Random	Press once: Random playback Press and hold: Toggle 12V on/off	Press once: No function Press and hold: Toggle external 12V power on/off
Play/pause	Press once: Play/Pause Press and hold: no function	Press once: Toggle mute Press and hold: no function
1 / DIR-	Press once: Back to previous folder Press and hold: No function	Press once: Listen to FM preset station 1 Press and hold: Set preset FM station 1
2 / REPEAT	Press once: Repeat function Press and hold: No function	Press once: Listen to FM preset station 2 Press and hold: Set preset FM station 2
3 / DIR+	Press once: Forward to next folder Press and hold: No function	Press once: Listen to FM preset station 3 Press and hold: Set preset FM station 3





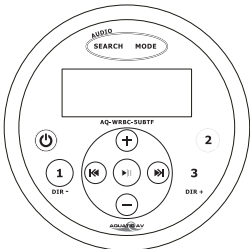

## 2.2 Wired Remote Control AQ-WRBC-5UBTF (sold separately)

**i** Please note Aquatic AV does not recommend wired remote controls are used for spa or hot tub applications as use in such applications is not covered by warranty.



Buttons	Music Mode: iPhone, iPod, Bluetooth, USB & MP3	FM Radio Mode
Power	Press once: Toggle from Operation mode to Standby mode or vice-versa.	
Mode	Press once: Change the source. Press and hold: Pair	Press once: Change the source. Press and hold: Pair
Search/Audio	Press once: NAVI search function Press and hold: Press and hold: Audio Menu (BAS-TRE-BAL-FAD-EUR-DX-MONO-STEREO)	Press once: Audio Menu (BAS-TRE-BAL-FAD-EUR-DX-MONO-STEREO)
Volume Up	Press once: Volume up Press and hold: Fast volume up	Press once: Volume up Press and hold: Fast volume up
Volume Down	Press once: Volume down Press and hold: Fast volume down	Press once: Volume down Press and hold: Fast volume down
Fast Rewind	Press once: Previous track Press and hold: Fast rewind	Press once: Scan down Press and hold: Toggle manual seeking
Fast Forward	Press once: Next track Press and hold: Fast forward	Press once: Scan up Press and hold: Toggle to manual seeking
Play/pause	Press once: Play/Pause Press and hold: no function	Press once: Toggle mute Press and hold: no function
1 / DIR-	Press once: Back to previous folder Press and hold: No function	Press once: Listen to FM preset station 1 Press and hold: Set preset FM station 1
2 / REPEAT	Press once: Repeat function Press and hold: No function	Press once: Listen to FM preset station 2 Press and hold: Set preset FM station 2
3 / DIR+	Press once: Forward to next folder Press and hold: No function	Press once: Listen to FM preset station 3 Press and hold: Set preset FM station 3







## 3.1 Listening via USB

2. Attach your device to the female USB socket the BlueCube+ Media Player using the appropriate USB adaptor. The AQ-USB-1 USB input socket/extension is available (sold separately).
3. Press  (MODE) on the remote control to select USB mode.
4. Press  to Play/Pause.
5. Press  /  (FAST REWIND/FORWARD) to play previous/next song file.
6. Press  (REPEAT) to active repeat playback function
7. Press  (RANDOM) to active random playback function



*Always ensure to connect and disconnect your media player with dry hands!*

### 3.1.1 iPhone & iPod Search

1. When using an iPhone or iPod, press  (SEARCH) to enter iPod searching mode.
2. Once in searching mode the remote will display 'Playlist'. Continue to press  (SEARCH) to scroll through the search modes below:
  - 1) Playlist 2) Artist 3) Album 4) Song 5) Genre 6) Composer 7) Audio Book
3. Press  (PLAY/PAUSE) To select the desired search mode.
4. Use  and  (Volume UP/DOWN) to scroll through your media in the selected search mode.
5. Once you find the desired media press  (PLAY/PAUSE) to make your selection. If your selection is a song it will begin to play, if you select a playlist, artist, album, genre, composer or audio book, the songs in the selected folder will be visible. Press  (PLAY/PAUSE) to play the desired song within the folder.

### 3.1.2 Device Charging

When specified USB devices are connected to the USB input the device battery will charge.

## 3.1.3 iPhone & iPod Compatible Models



iPhone 4  
8GB 16GB 32GB



iPhone 4s  
16GB 32GB 64GB



iPhone 5  
16GB 32GB 64GB



iPhone 5c  
16GB 32GB



iPhone 5s  
16GB 32GB 64GB



iPhone 6  
16GB 64GB 128GB



iPhone 6 Plus  
16GB 64GB 128GB



iPod touch  
4th generation  
8GB 16GB 32GB 64GB



iPod touch  
5th generation  
16GB 32GB 64GB

## 3.2 Listening via Bluetooth

IAP Bluetooth connectivity allows device information, such as song, playlist and album titles, to be streamed wirelessly and viewable on the remote control.

### 3.2.1 Pair with Bluetooth Device

1. Switch on your Bluetooth device.
2. Select 'AQUATIC AV' from the list of available devices to pair (no password is needed).

**i** Only one Bluetooth device can be paired with the BlueCube+ Media Player at any time.

### 3.2.2 Listening via Bluetooth Device

1. Bluetooth mode will be activated once a Bluetooth device is paired.
2. Play the song from device and the sound will play through the BlueCube+ Media Player.
3. Press (PLAY/PAUSE) to play/pause the song.
4. Press / (FAST REWIND/FORWARD) buttons to play previous/next song file.
5. Track and volume can be controlled directly from your Bluetooth device, remote control or door controls.

## 3.3 Listening via Auxiliary Input

1. Connect your MP3 device to the RCA inputs.
2. Press (MODE) on the remote control to select 'AUX IN' mode.

**i** Only one Auxiliary input (RCA) can be used at any one time.

## 3.4 Adjust Volume Level

1. Press (VOLUME UP) once to increase the volume.
2. Press (VOLUME DOWN) once to reduce the volume.
3. Press and hold either or and the BlueCube+ Media Player will increase or decrease audio volume continuously.







## 4.1 Enter FM Radio Mode

1. Press  (MODE) on remote control to switch to FM radio mode.

**i** If this is the first time you listen to FM radio, the default frequency will be 87.5MHz, as shown on the remote LCD.



**i** FM radio is only available when you are in the FM Radio mode.

## 4.2 Scan or Seek FM Radio Channels



1. Press  (FAST REWIND) or  (FAST FORWARD) to seek another station.
2. Press and hold either  (FAST REWIND) or  (FAST FORWARD) for manual tuning back or forward.

**i** After using Seek mode the unit will automatically switch back into Scan mode after 20 seconds.



## 4.3 Saving Radio Channel to Memory

To save the current frequency into memory, press and hold  ,  or  for more than 2 seconds. The station will be stored into relevant button.

## 4.4 Listening to Saved Radio Memory

Press the  ,  or  preset button once to listen to the station stored in that button.





## 4.5 Switch between US and European FM Modes

1. Make sure the remote control is turned on and the BlueCube+ Media player is in 'RADIO' mode.
2. Press the AUDIO button 6 times in a row.
3. The remote will display 'AREA USA' or 'AREA EUR' depending on which tuning mode is currently selected.
4. Use the  and  buttons to switch between US or European modes.
5. Press  (PLAY/PAUSE) to select the desired tuning mode.
6. Once you switch modes it will default to the FM station stored in 'PRESET'.

**i** US mode will increase and decrease the FM frequency in steps of 0.1 MHz, e.g. 88.5, 88.6, 88.7 MHz. EUR mode will increase and decrease the FM frequency in steps of 0.05 MHz, e.g. 88.25, 88.30, 88.35 MHz.

**i** When in Seek mode and European FM tuning mode, all frequency steps will be visible.

## 4.6 Adjust Volume Level

1. Press  (VOLUME UP) once to increase the volume.
2. Press  (VOLUME DOWN) once to reduce the volume.
3. Press and hold either  or  and the BlueCube+ Media Player will increase or decrease audio volume continuously.

## 5.1 External 12V Trigger

Aquatic AV understands the need for more flexible remote applications. With the BlueCube+ Media Player Aquatic AV has provided an independent 12V 'accessory' trigger, activated from the RF wireless remote. This could activate any 12V based device like 12V lights or 12V motors.

In any operational mode, press the  (12V TRIGGER) key to activate. Press again to deactivate.

 *Aquatic AV strongly recommend you speak to our technical service staff or your local Aquatic AV dealer if you are considering using this feature.*

 *Load on External Trigger should not exceed 350mA.*

## 6.1 Specifications

### Media

Supported media.....A2DP & IAP Bluetooth/USB/iPod/iPhone/MP3/FM/AUX  
Device charging.....via USB  
Device control.....via RF Remote Control or Wired Remote Control

### Inputs

USB.....USB 2.0  
Auxiliary.....1x stereo pair RCA input

### Outputs

Pre-Out.....2x stereo pair RCA (4V)

### FM Radio

FM pre-sets.....3  
US/Euro frequencies.....Yes

### Power

Output voltage @ 2 Ohm.....4x 72W  
Output voltage @ 4 Ohm.....4x 45W  
Operation voltage.....9.6V - 14.4V DC (Chian has old specs??)  
Max current draw.....7A  
Standby current draw.....6mA

### Multi-Environment Certifications

Waterproof / Dustproof.....Yes IP65 (Remote Control rated IP66)  
Conformal PCB coating.....Yes  
UV protection.....500 hours stable, ASTM D4329 compliant  
Salt/Fog protection.....500 hours stable, ASTM B117 compliant  
Stainless Steel mountings.....Yes

## 6.2 Dimensions

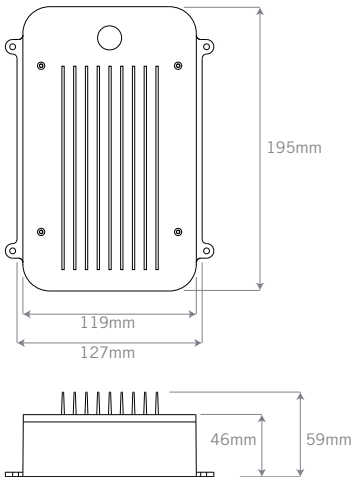

Aquatic AV offers a limited warranty of our products on the following terms:

**Length of warranty**

2 years on audio systems, electronics, speakers, and accessories (receipt required).

**Coverage**

This warranty covers only the original purchaser of a Aquatic AV product purchased from an authorized Aquatic AV dealer in the United States. In order to receive service, the purchaser must provide Aquatic AV with a copy of the receipt stating the customer name, dealer name, product purchased and date of purchase.

**Defective products**

Products found to be defective during the warranty period will be repaired or replaced (with a product deemed to be equivalent) at Aquatic AV's discretion.

**What is not covered**

Damage caused by accident, abuse, improper operations, theft. Any cost or expense related to the removal or reinstallation of product. Service performed by anyone other than an authorized Aquatic AV service center. Any product with the serial number or tamper labels defaced, altered, or removed. Subsequent damage to other components. Any product not purchased from an authorized Aquatic AV dealer.

**Limit on implied warranties**

Any implied warranties including warranties of fitness for use and merchantability are limited in duration to the period of the express warranty set forth above. Some states do not allow limitations on the length of an implied warranty, so this limitation may not apply. No person is authorized to assume for Aquatic AV any other liability in connection with the sale of the product.

**How to obtain service**

You must obtain a return material authorization number (RMA) to return any product to Aquatic AV. You are responsible for shipping charges of returned products to Aquatic AV.

Please record the model and serial number[s] of your equipment in the space provided below as your permanent record and will assist us with your factory warranty coverage. These numbers can be found on the rear of the BlueCube+ Media Player.

Model number[s]:	Serial number[s]:

FCC ID:  
MADE IN CHINA

This device complies with Part 15 of the FCC Rules. Operation is subject to the following two conditions: (1) this device may not cause harmful interference, and (2) this device must accept any interference received, including interference that may cause undesired operation.

**NOTE:**

The equipment has been tested and found to comply with the limits for a Class B digital device, pursuant to Part 15 of the FCC Rules. These limits are designed to provide reasonable protection against harmful interference in a residential installation. This equipment generates, uses and can radiate radio frequency energy and, if not installed and used in accordance with the instructions, may cause harmful interference to radio communications. However, there is no guarantee that interference will not occur in a particular installation.

If this equipment does cause harmful interference to radio or television reception, which can be determined by turning the equipment off and on, the user is encouraged to try to correct the interference by one or more of the following measures:

- Reorient or relocate the receiving antenna.
- Increase the separation between the equipment and receiver.
- Consult the dealer or an experienced radio/TV technician for help.

The manufacturer is not responsible for any radio or TV interference caused by unauthorized modifications to this equipment. Such modifications could void the user authority to operate the equipment.

iPhone, iPod and iPod Touch are trademarks of Apple Inc., registered in the U.S. and other countries.

Made for iPod and Made for iPhone mean that an electronic accessory has been designed to connect specifically to iPod or iPhone respectively, and has been certified by the developer to meet Apple performance standards. Apple is not responsible for the operation of this device or its compliance with safety and regulatory standards. Please note that the use of this accessory with iPod or iPhone may affect wireless performance.

Product design and specification subject to change without notice. E&OE.

Doc V2.1



## **Aquatic AV**

282 Kinney Drive  
San Jose, CA 95112, USA

**E-mail:** [info@aquaticav.com](mailto:info@aquaticav.com)

**US & Canada:** 1 877 579 2782

**International:** +1 408 559 1668

**Fax:** +1 408 559 0125

**[www.aquaticav.com](http://www.aquaticav.com)**



**products with a watertight reputation**